

WIATA GARAŻOWA GRANIT I 300 x 500

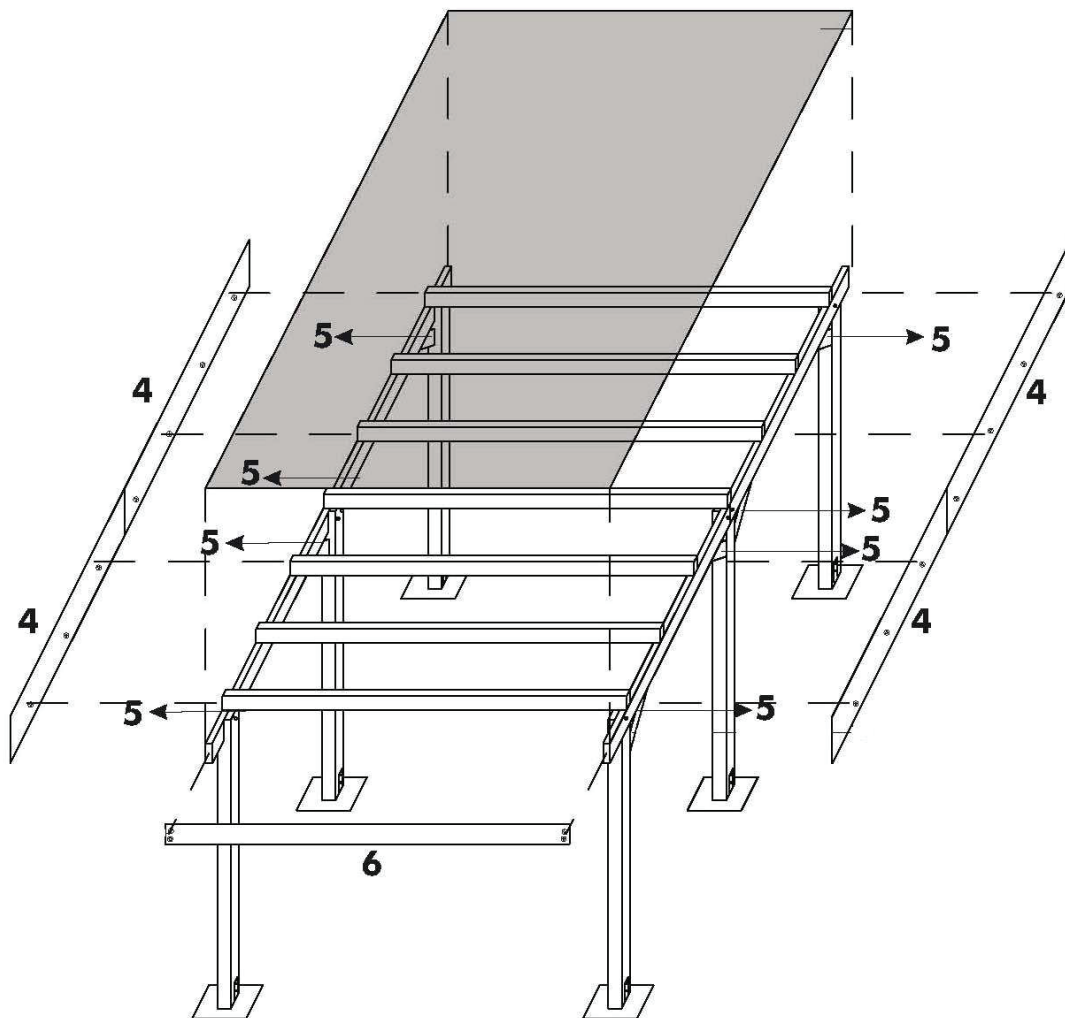

LISTA ELEMENTÓW

LP	ELEMENT	WYMIARY	SZTUKI
1	Słupki	9 x 9 x 210 cm	6
2	Belki nośne	4 x 12 x 250 cm	4
3	Belki dachowe	4 x 10 x 300 cm	7
4	Deski boczne	2 x 12 x 250 cm	4
5	Zastrzały	4 x 10 x 40 cm	8
6	Deska czołowa	2 x 12 x 304 cm	1

