

2

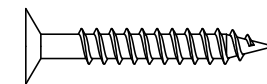
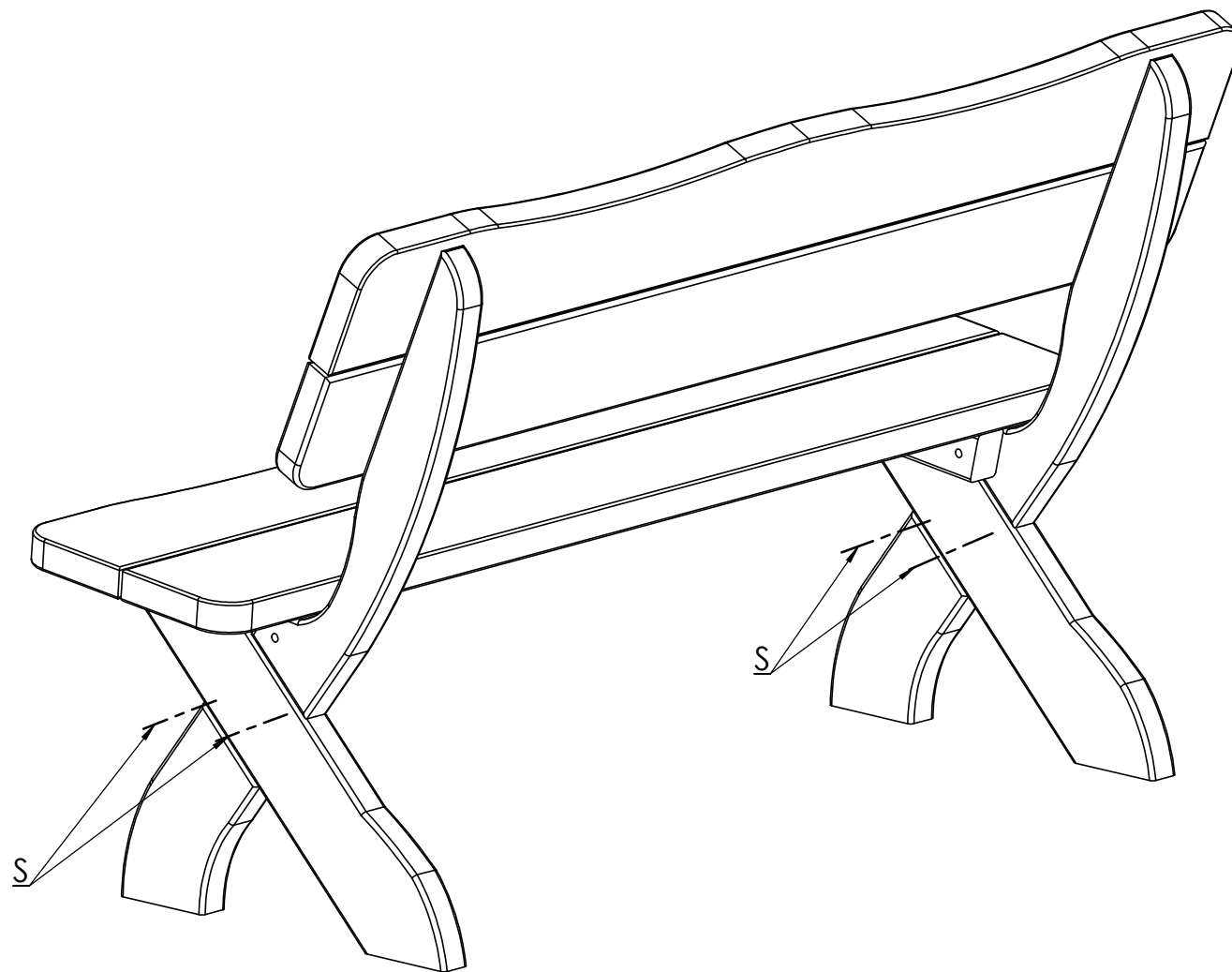

S 5x35 x4