



KAROL

DOMEK ZABAW

110 x 95 cm







UWAGA!!



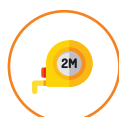

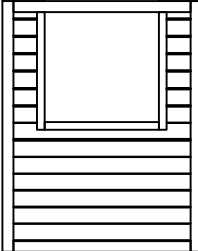
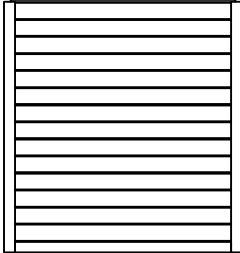
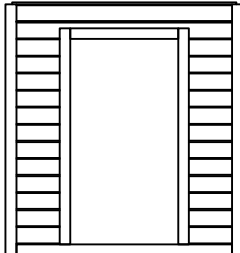
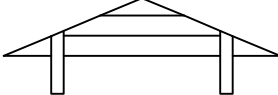

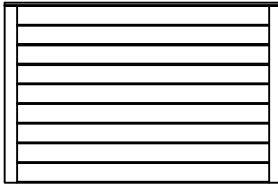
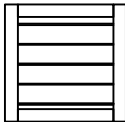
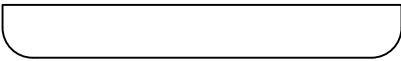
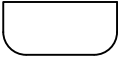

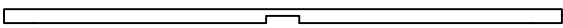
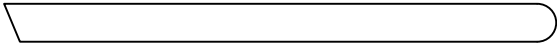
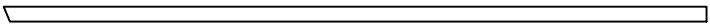
Przed rozpoczęciem pracy należy szczegółowo zapoznać się z instrukcją.
Przybliżony czas montażu dla dwóch osób to 8 godzin.

NIEZBĘDNE NARZĘDZIA

Ołówek, metrówka, poziomica, młotek, wkrętaka, młot do kotew wbijanych lub wiertarka do mocowania kotew do twardego podłoża.

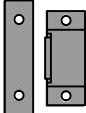
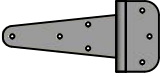

NR	DIMENSION	PCS	PHOTO
A	920x1172x30	2	
B	1100x1172x30	1	
C	1100x1172x30	1	
D	1097x230x45	2	
E	1100x1000	2	
F	1100x715x30	2	
G	480x465x30	1	
H	15x70x528	1	
J	15x70x150	1	
K	25x35x60	1	
L	15x35x570	1	
M	15x35x590	1	
N	15x50x730	4	
O	15x35x715	4	

I = 4 3,0x16	II = 23 4,0x25	III = 39 4,0x35	IV = 19 4,0=45	V = 1 4,0x55	VI = 2 4,5x70	VII = 1	VIII = 2	IX = 3 2,5x15
								

IV - 4,0x45 #11 

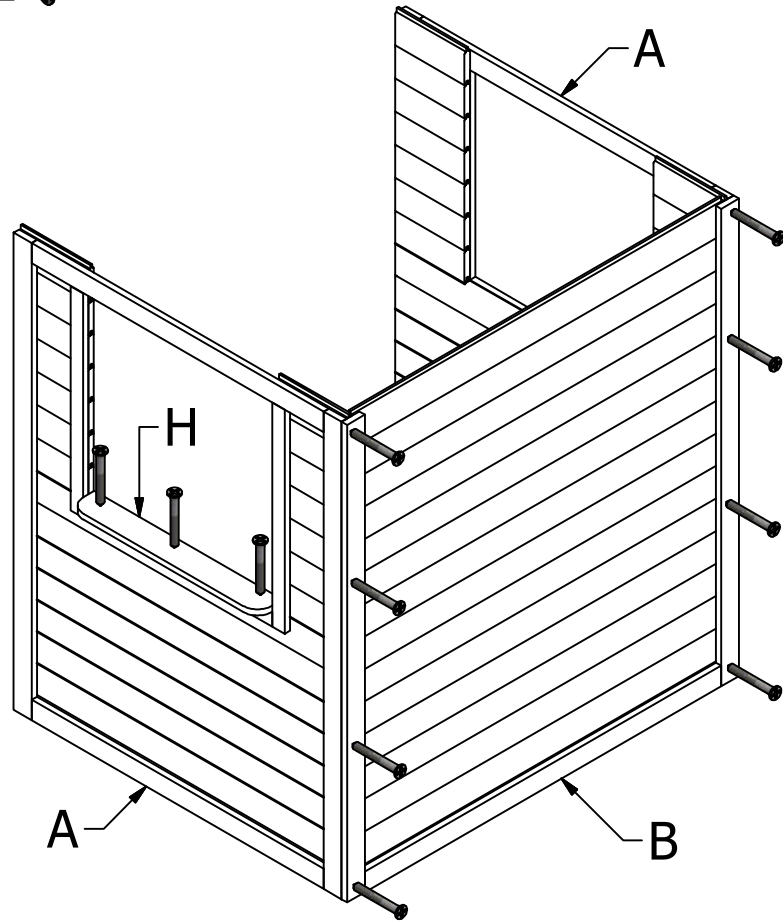
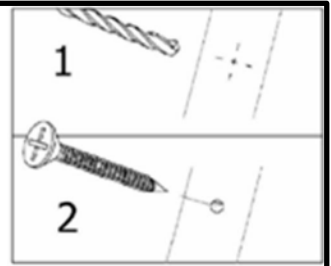

II - 4,0x25 #1 

III - 4,0x35 #3 

IV - 4,0x45 #8 

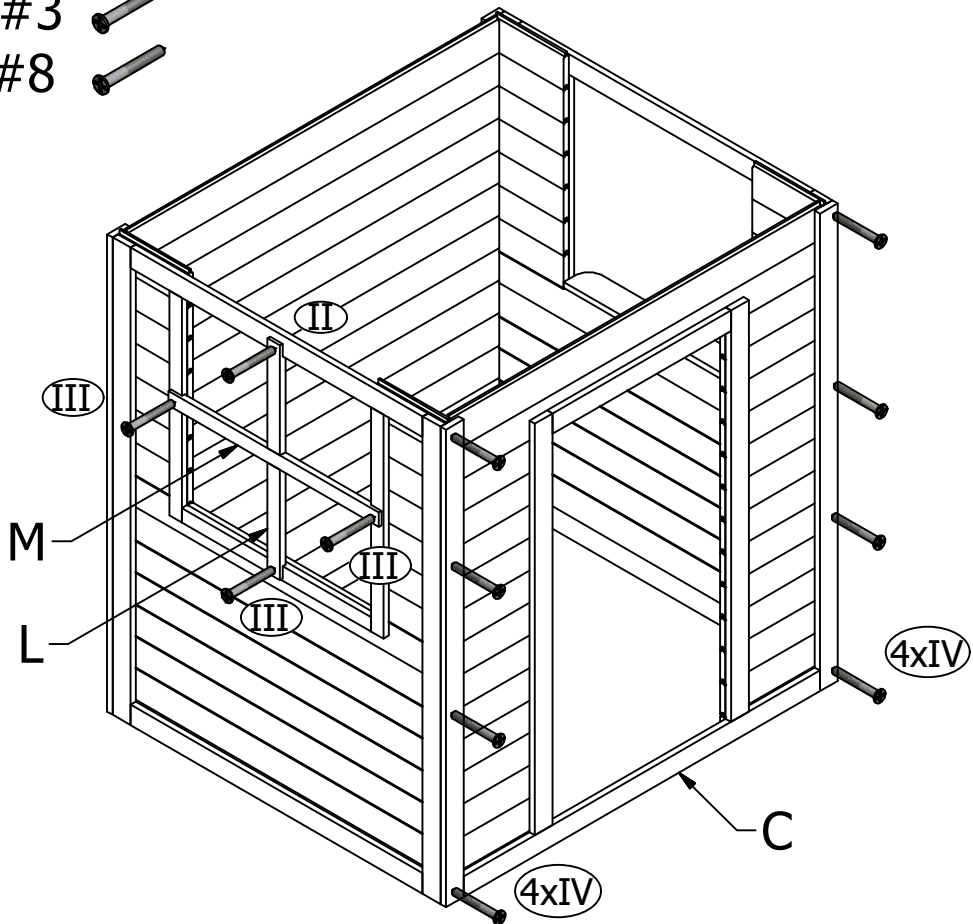

II - 4,0x25 #14



VIII #2

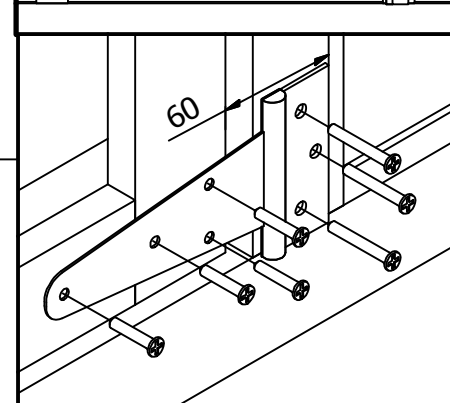
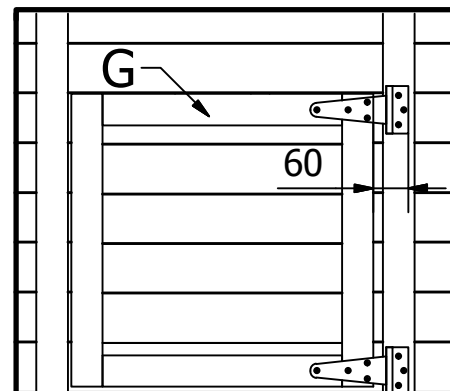
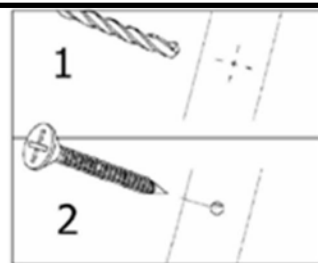
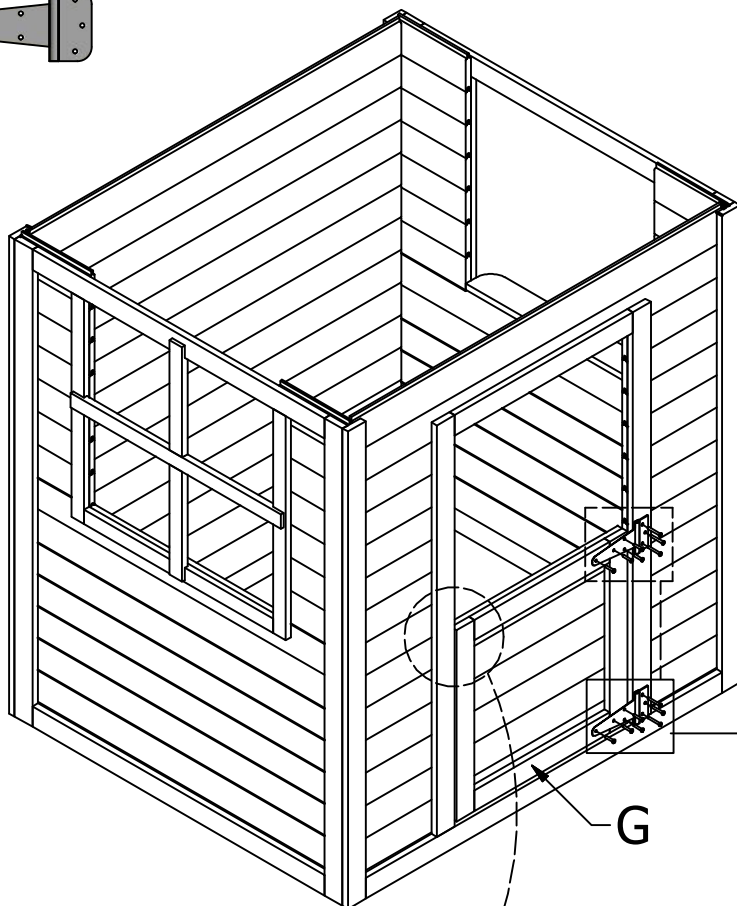
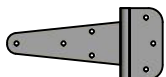

I - 3,0x16 #4



V - 4,0x55 #1



VII #1

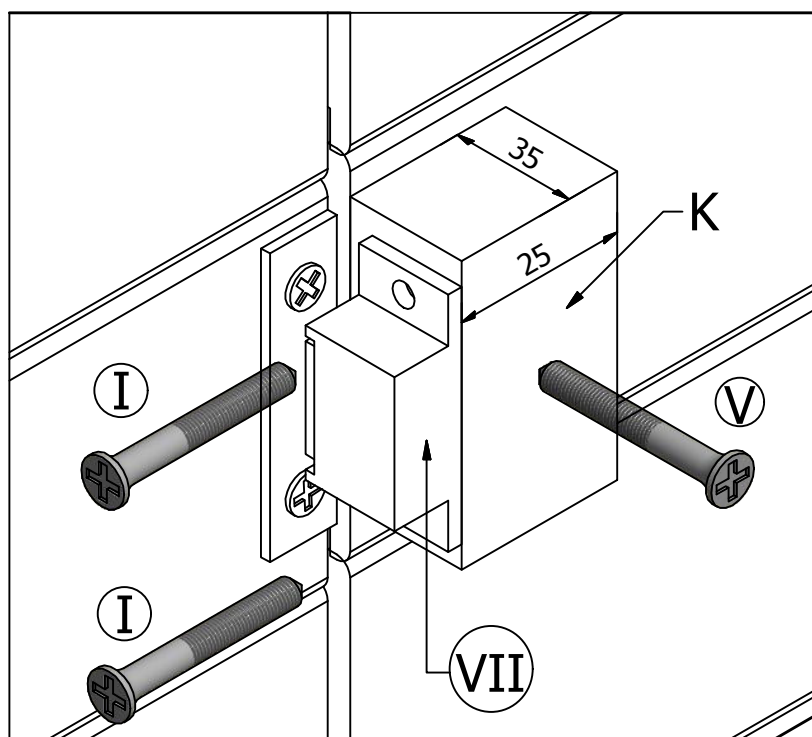
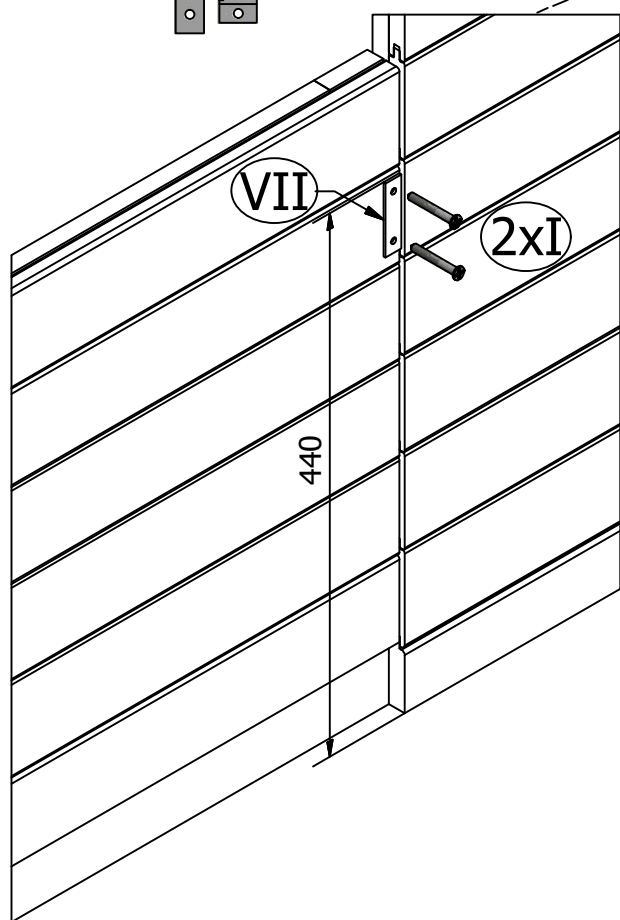
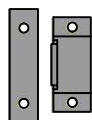

VI - 4,5x70 #2 

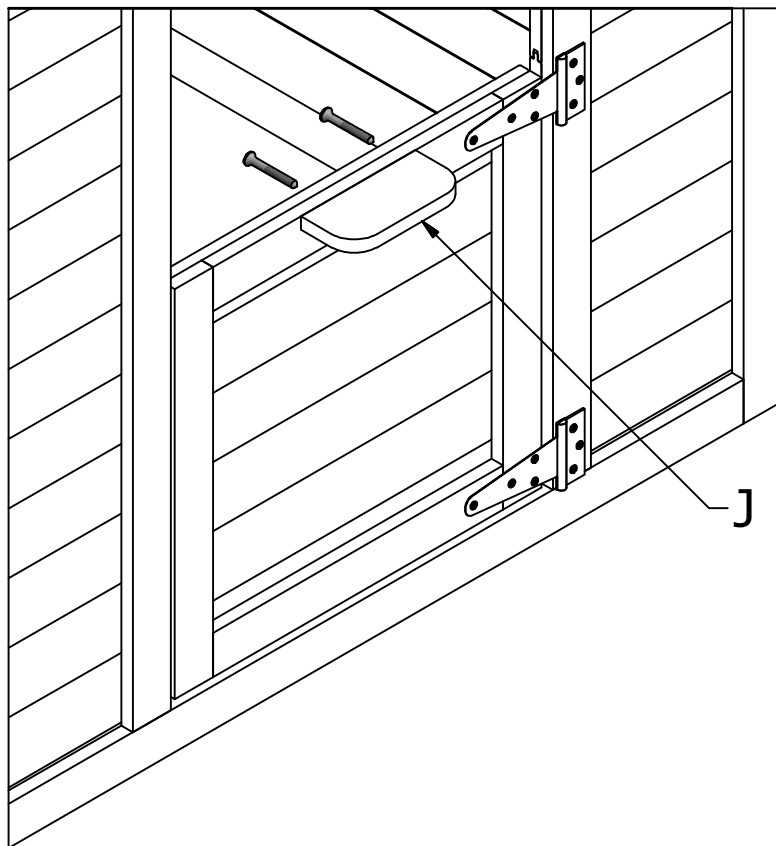

II - 4,0x25 #8 

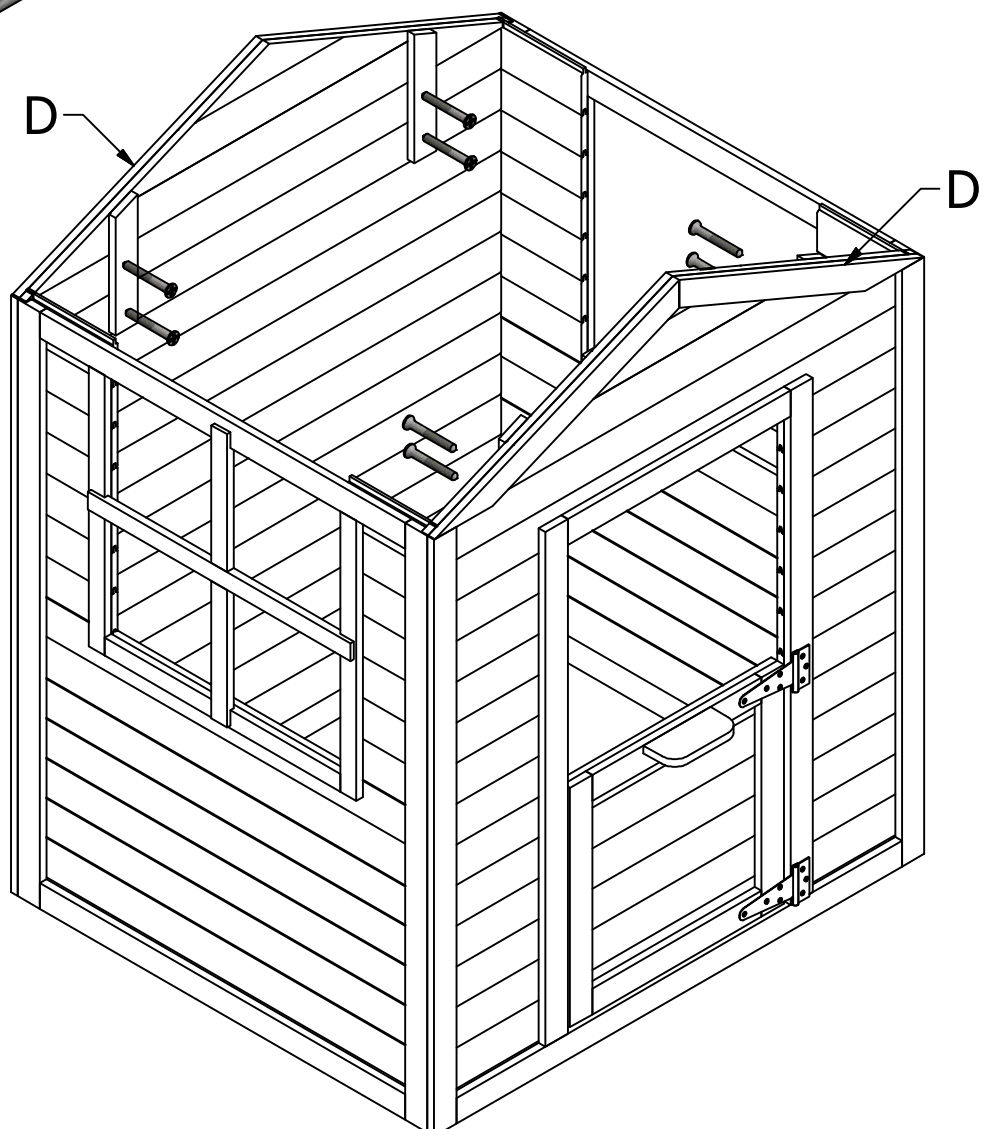

III - 4,0x35 #12

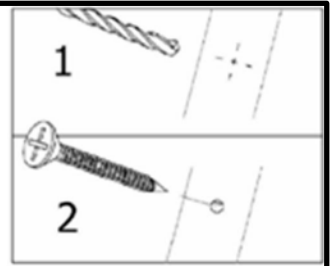
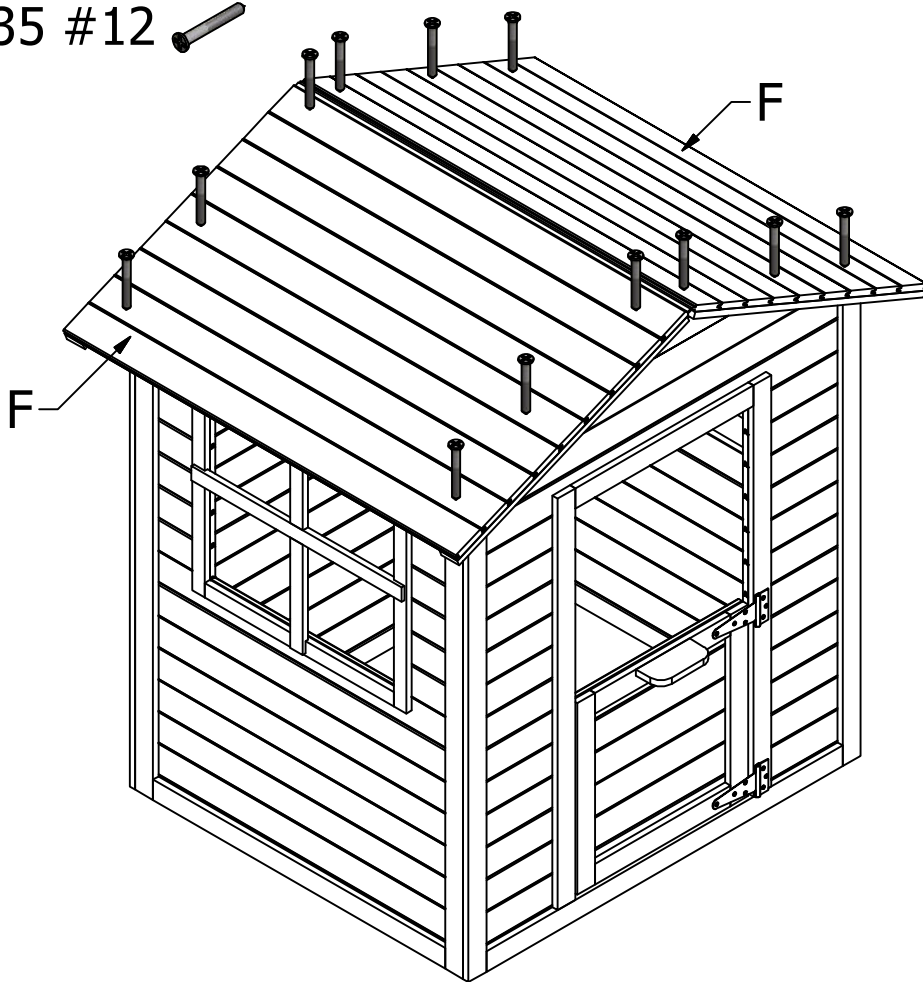

IX - 2,5x15 #3
III - 4,0x35 #24

