



DOMEK ZABAW

OLIWIA



UWAGA!!



Przed rozpoczęciem pracy należy szczegółowo zapoznać się z instrukcją.

PRZYDATNE NARZĘDZIA

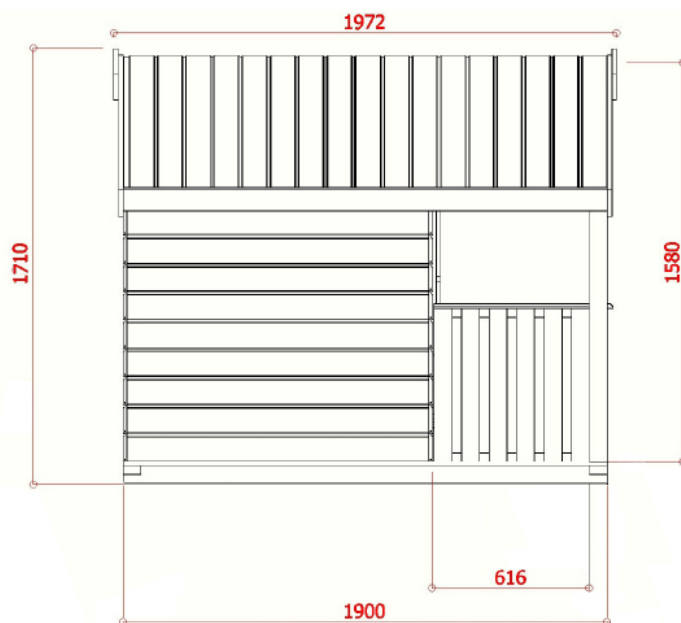
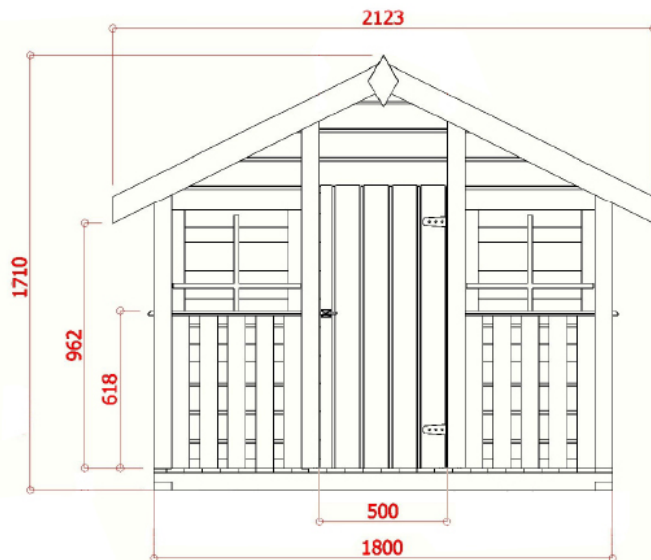

DOMEK ZABAW OLIWIA



	3,42 m ²
	4,19 m ²

	Wejście 1085 500
---	-------------------------------

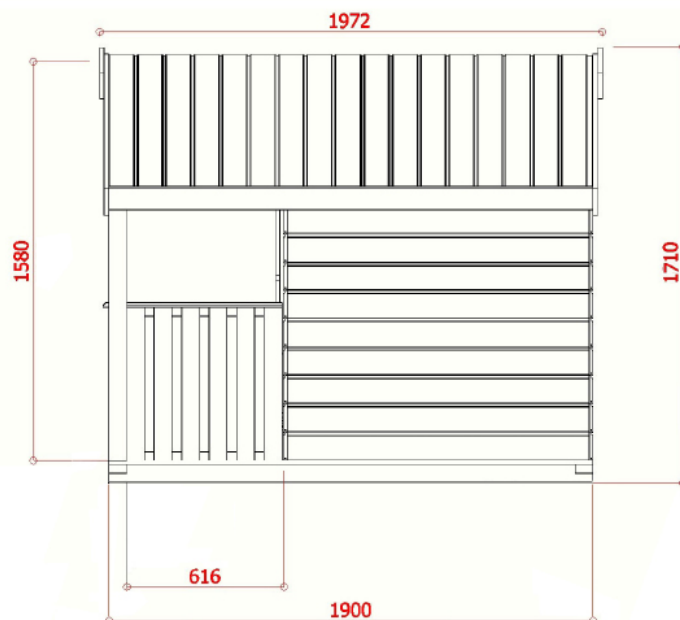
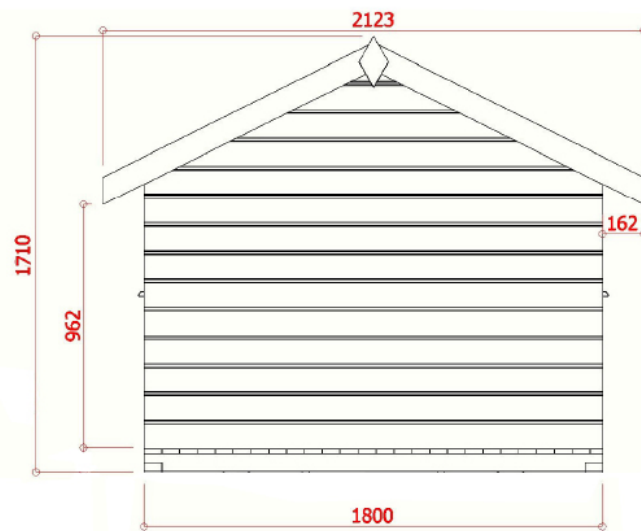

Skala: 1:30

DOMEK ZABAW OLIWIA





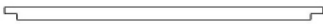

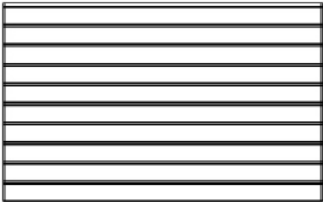
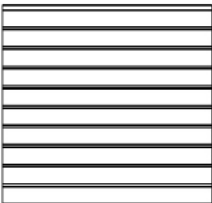
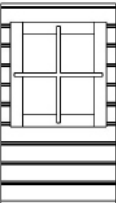
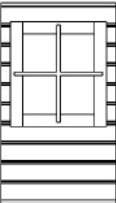
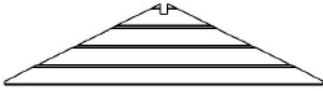
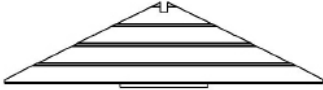



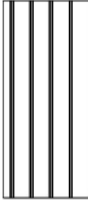
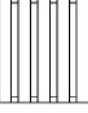

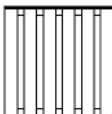

Skala: 1:30

DOMEK ZABAW OLIWIA

	Ref.		Index	#
	B	- B - 40x70	1900	2
	C	- C - 40x70	1800	2
	E	- E - 40x70	1760	1
	F	- F - 18x90	1800	21
	G	- G - 1120x1800		1
	H	- H - 1120x1185		2
	I	- I - 650x1120		1
	J	- J - 650x1120		1
	K	- K - 1800x455		1
	L	- L - 1800x455		1

DOMEK ZABAW OLIWIA

	Ref.		L	Index	#
	M	- M - 480x1085		1	
	N	- N - 615x510		2	
	O	- O - 70x70	1165	2	
	P	- P - 70x70	1450	2	
	R	- R - 610x615		2	
	S	- S - 40x70	1900	1	
	T	- T - 40x58	1900	2	
	U	- U - 121x18	1160	34	
	W	- W - 15x70	1195	4	
	Y	- Y - 18x200		2	
	Q	3 x 16 (8) 3 x 25 (12) 3 x 30 (20) 4 x 60 (54) 6 x 120 (12)			
		2.5 x 40 (211)			
				2	
				1	

DOMEK ZABAW OLIWIA

B = 2
C = 2
E = 1

1

6 x 120

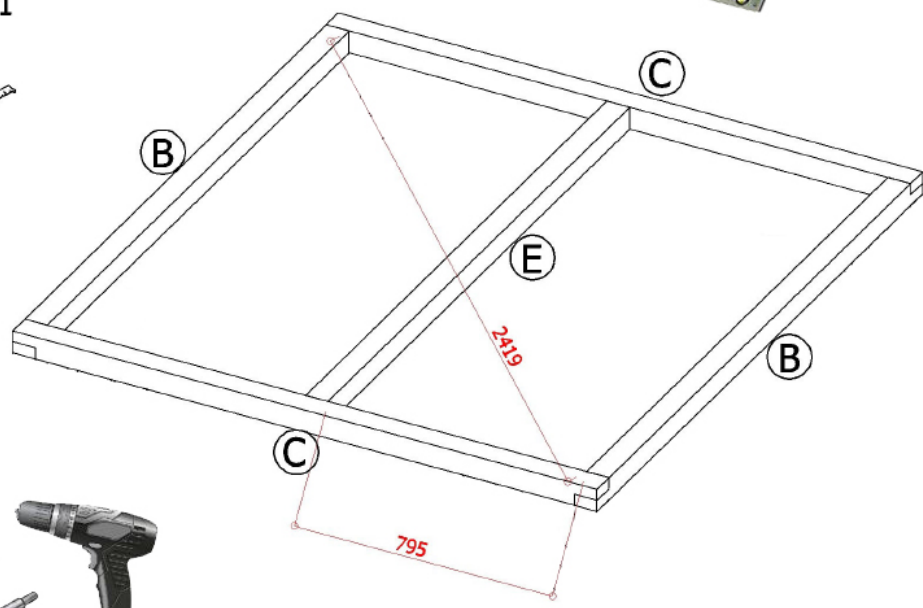
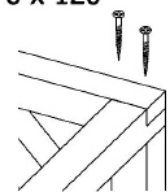

6 x 120 (12)

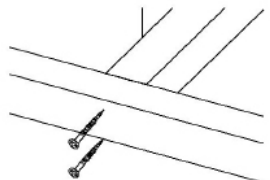

6 x 120

F = 21

2.5 x 40 (135)

2

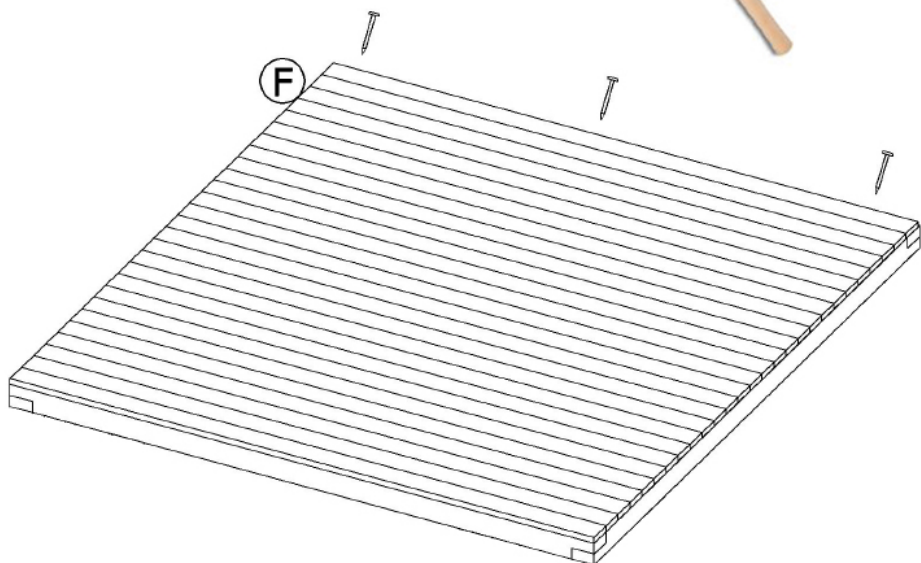

DOMEK ZABAW OLIWIA

G = 1

H = 2

 4 x 60 (10)

(H)

(G)

3

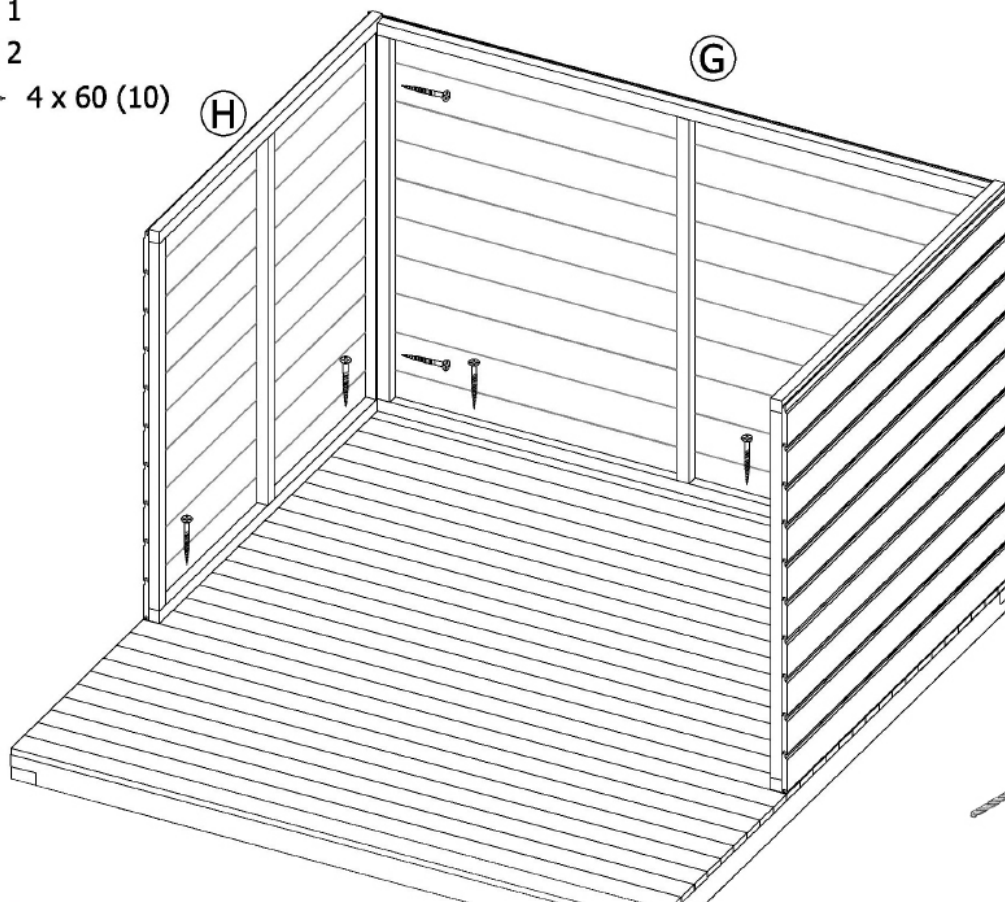

I = 1

J = 1

 4 x 60 (8)

(I)

(J)

4

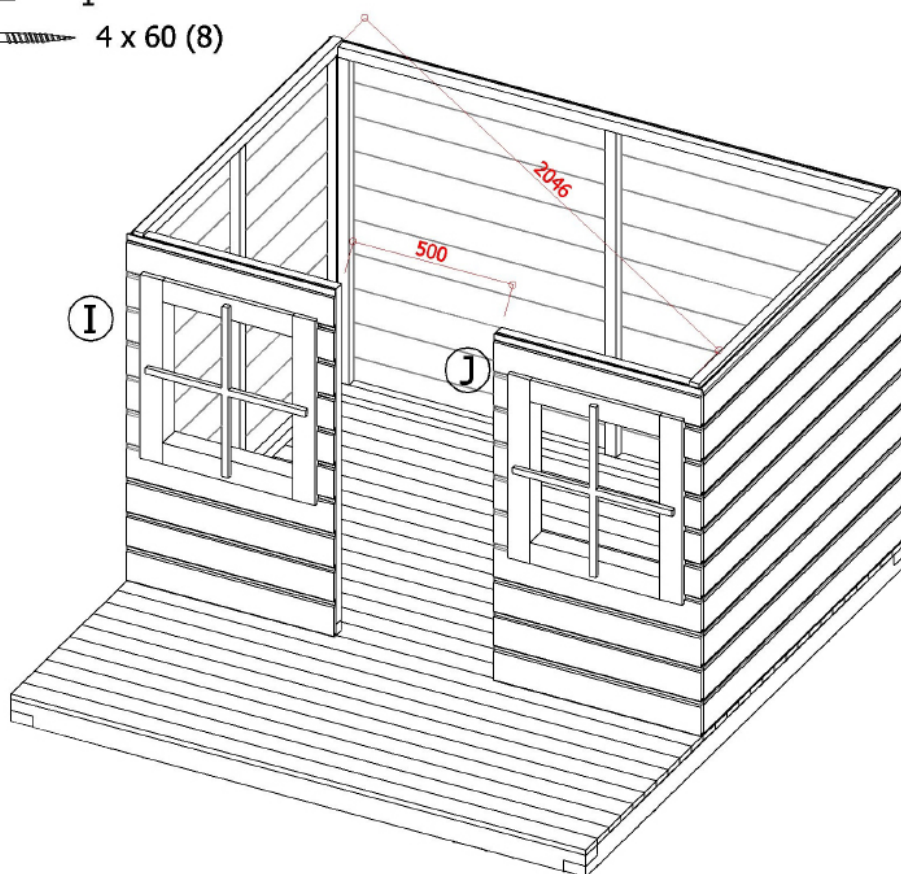

DOMEK ZABAW OLIWIA

K = 2

L = 1

 4 x 60 (4)

5

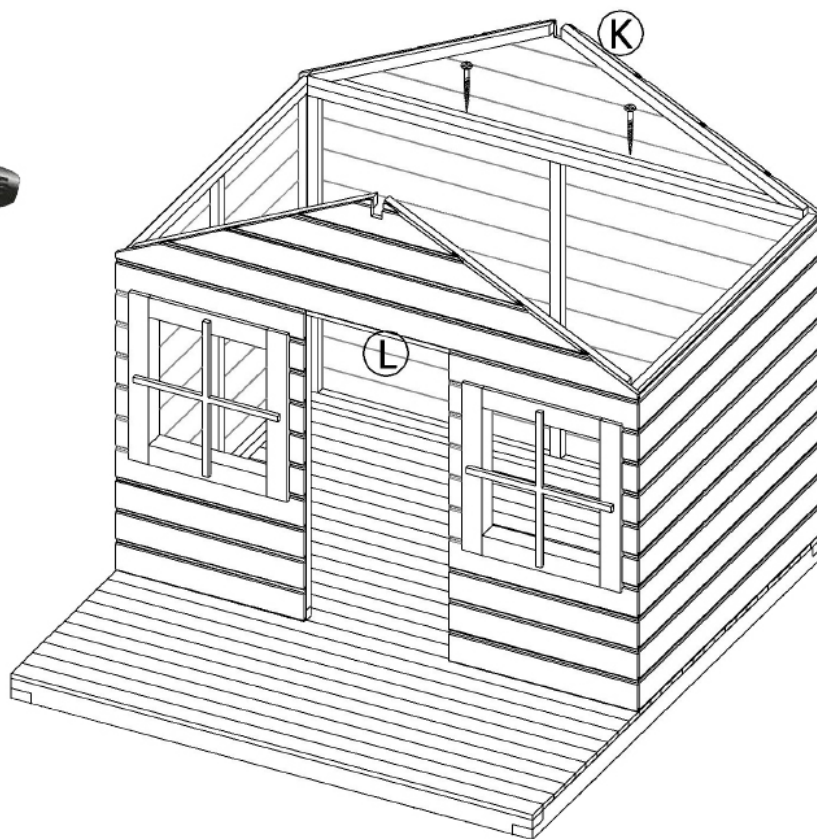

M = 1

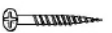
 3 x 25 (12)

 3 x 16 (8)



6

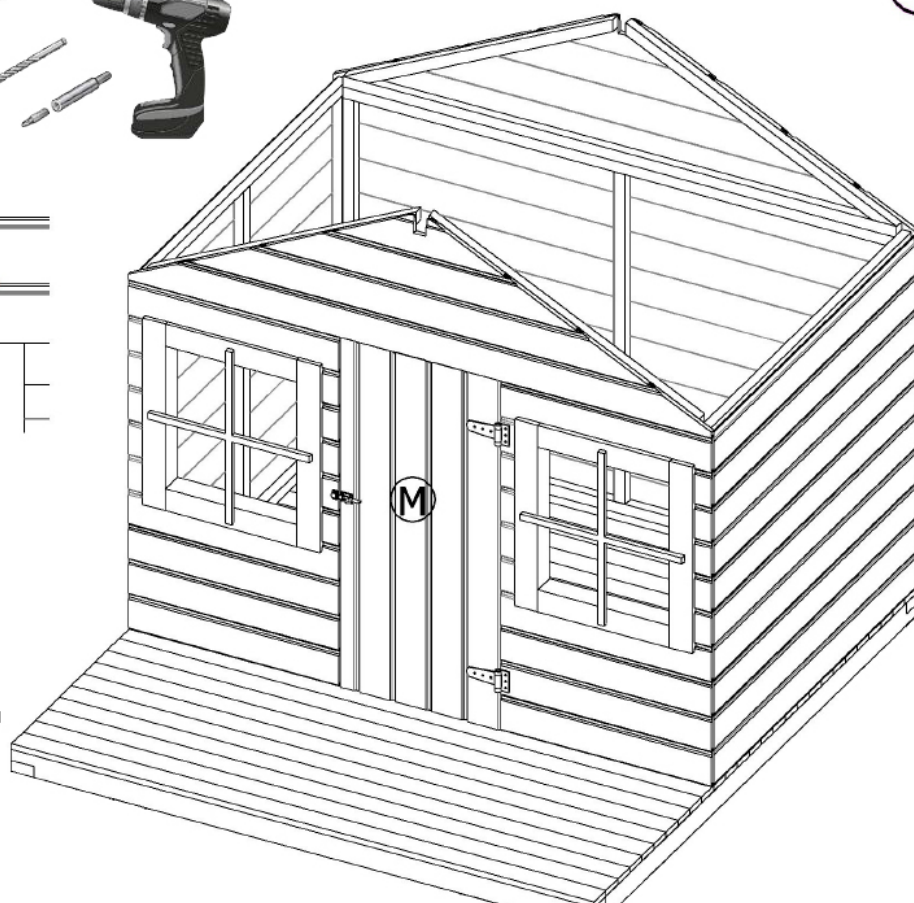
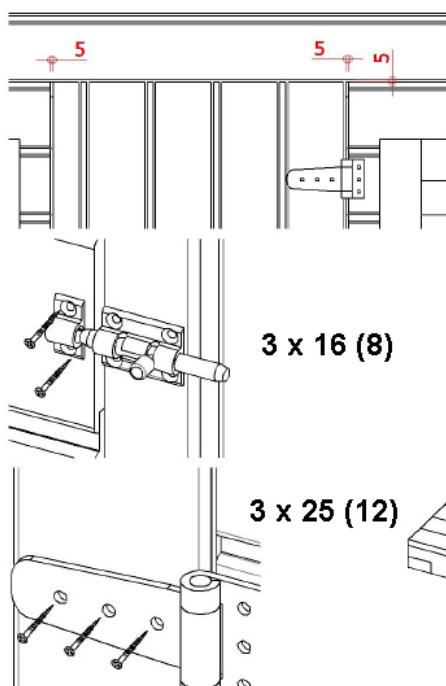

DOMEK ZABAW OLIWIA

N = 2
O = 2
4 x 60 (12)

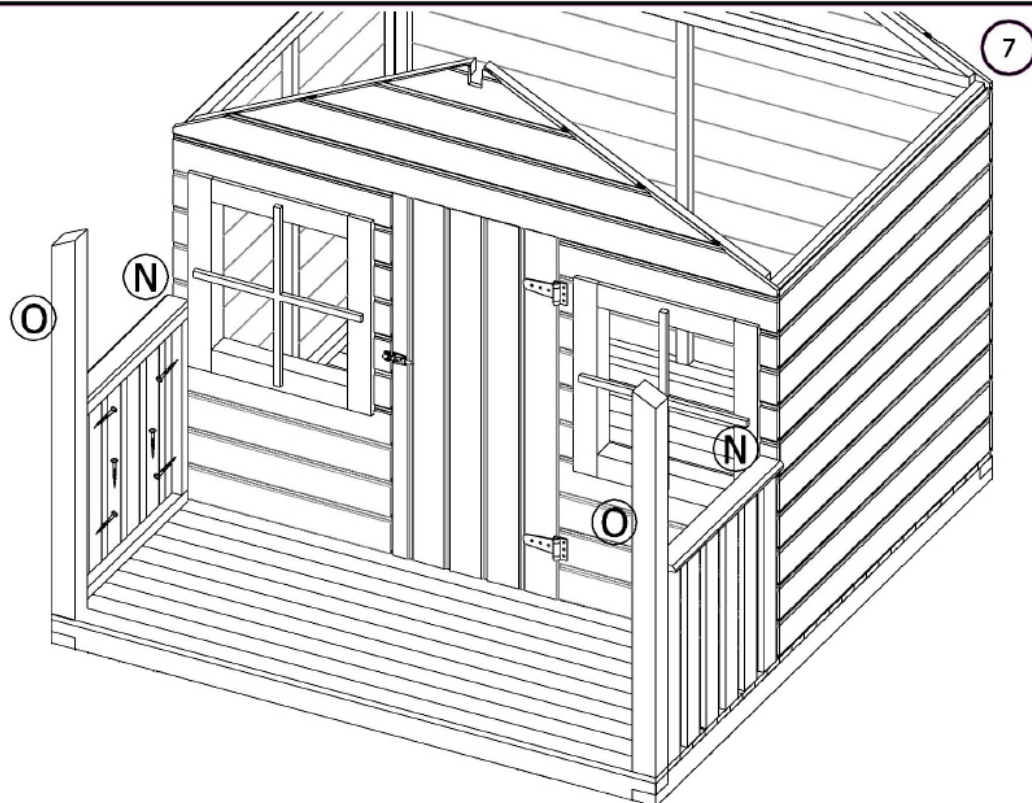

P = 2
R = 2
4 x 60 (12)

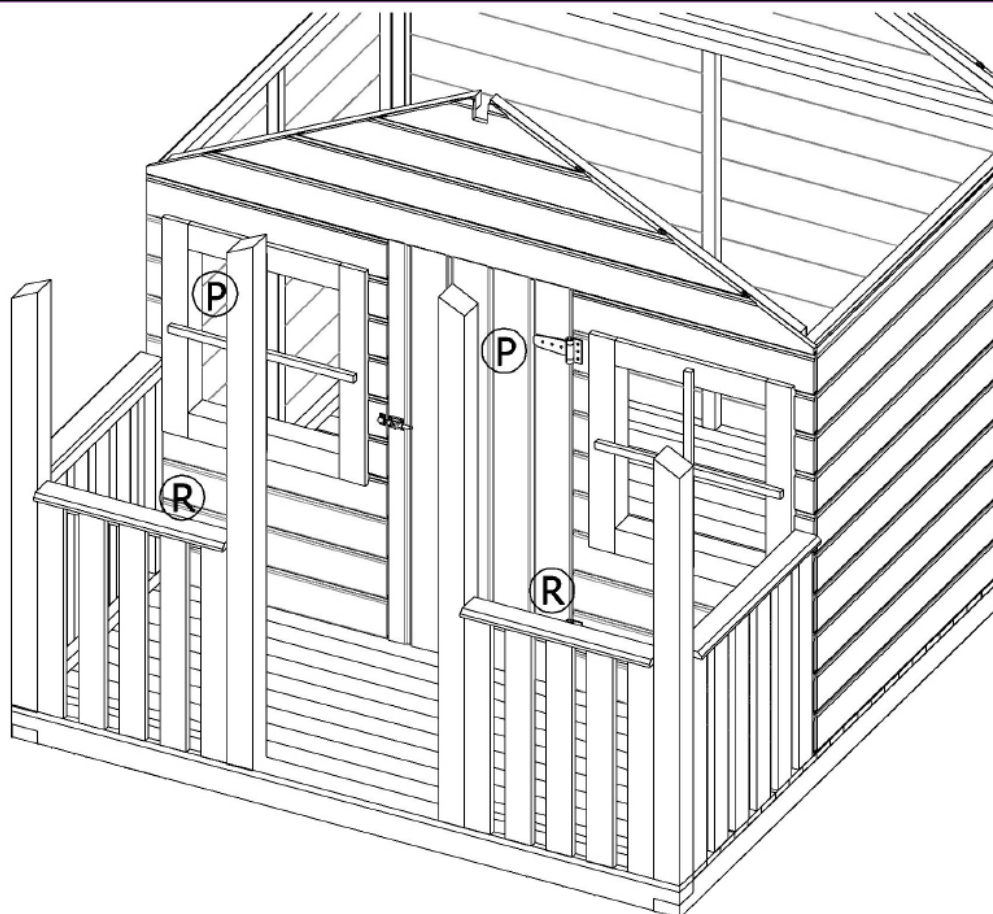

DOMEK ZABAW OLIWIA

S = 1

T = 2

 4 x 60 (12)

8

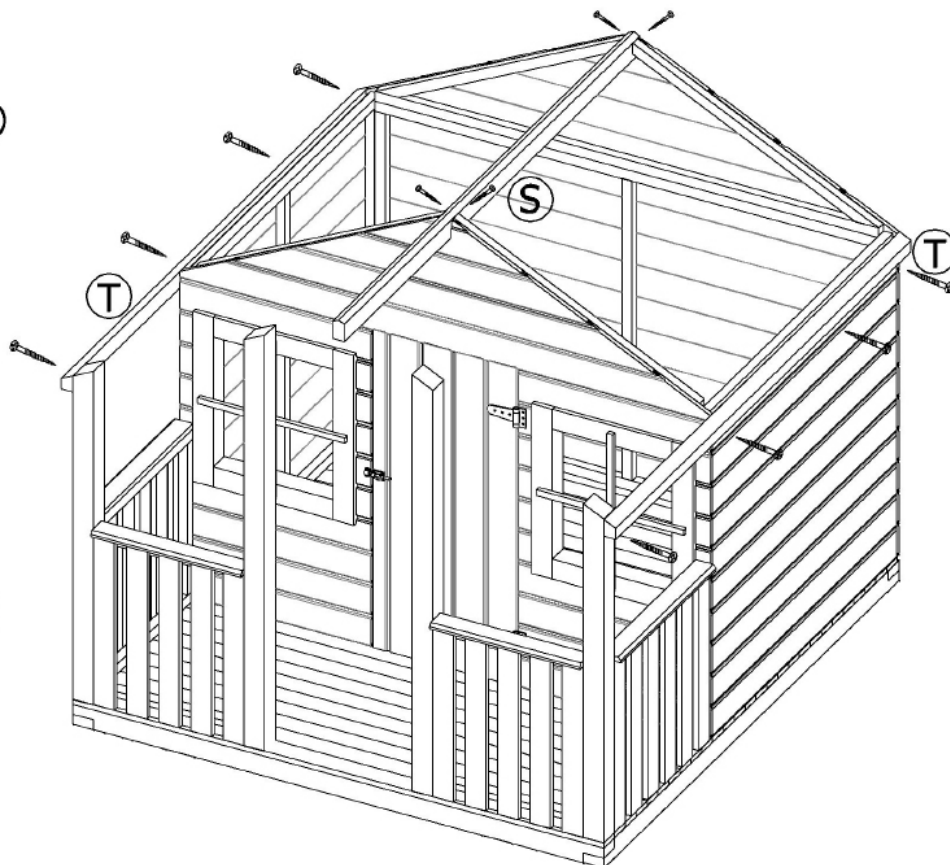

U = 34

 2.5 x 40 (76)

9



!

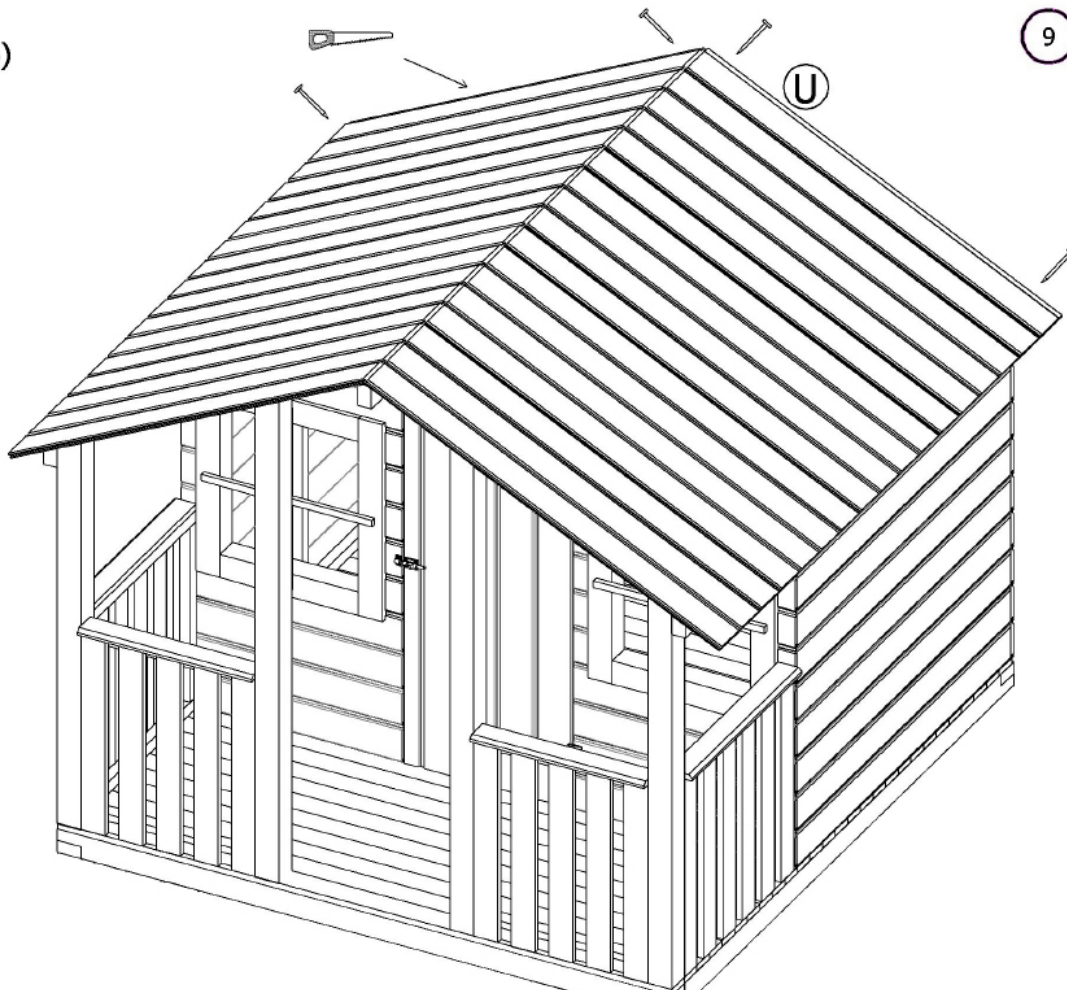

DOMEK ZABAW OLIWIA

W = 4

Y = 2

 3 x 30 (20)

