



ZADASZENIE KVH

SŁUPKI 12 x 12 cm

300 cm

ZASTRZAŁ PROSTY

500 x 525



NIEZBĘDNE NARZĘDZIA

Ołówek, metrówka, poziomica, młotek, wkrętaka, drabina, młot do kotew wbijanych lub wiertarka do mocowania kotew do twardego podłoża.



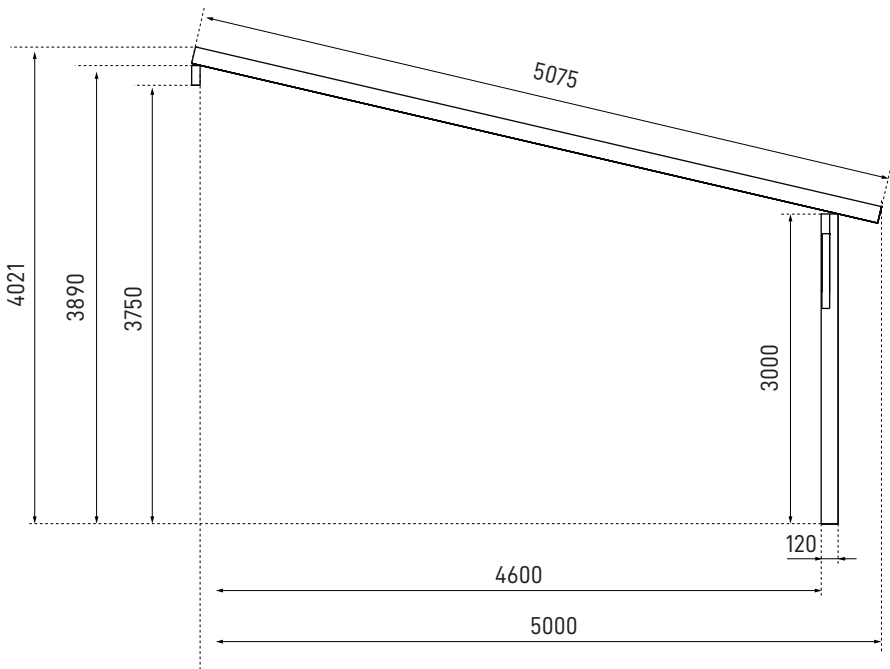
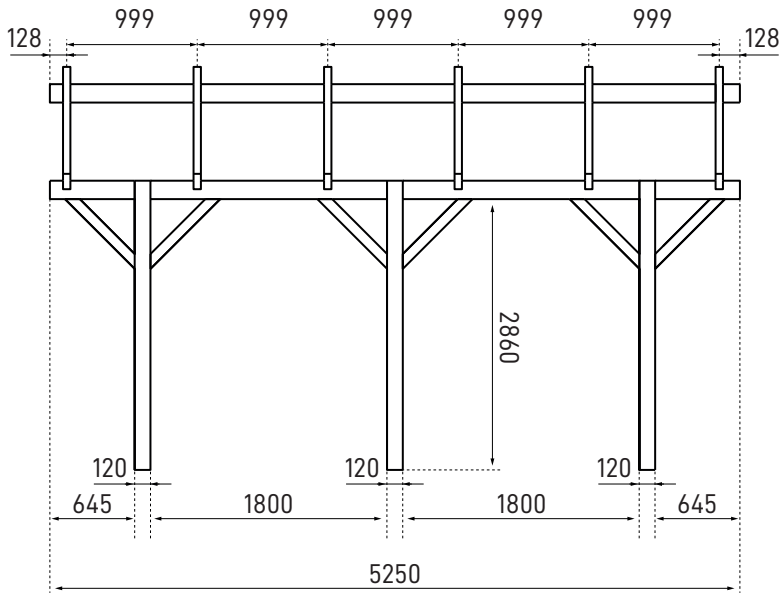

WYKAZ ELEMENTÓW

LP	NAZWA	WYMIAR	SZT.
1	Słup	120 x 120 x 3000 mm	3
2	Belka nośna	60 x 140 x 5250 mm	2
3	Krokiew	60 x 120 x 5075 mm	6
4	Zastrzał	60 x 120 x 750 mm	6
A	Nakrętka	M8	6
B	Podkładka	M8	6
C	Śruba	8 x 130	6
D	Wkręt	5 x 120	12
E	Wkręt	8 x 160	12

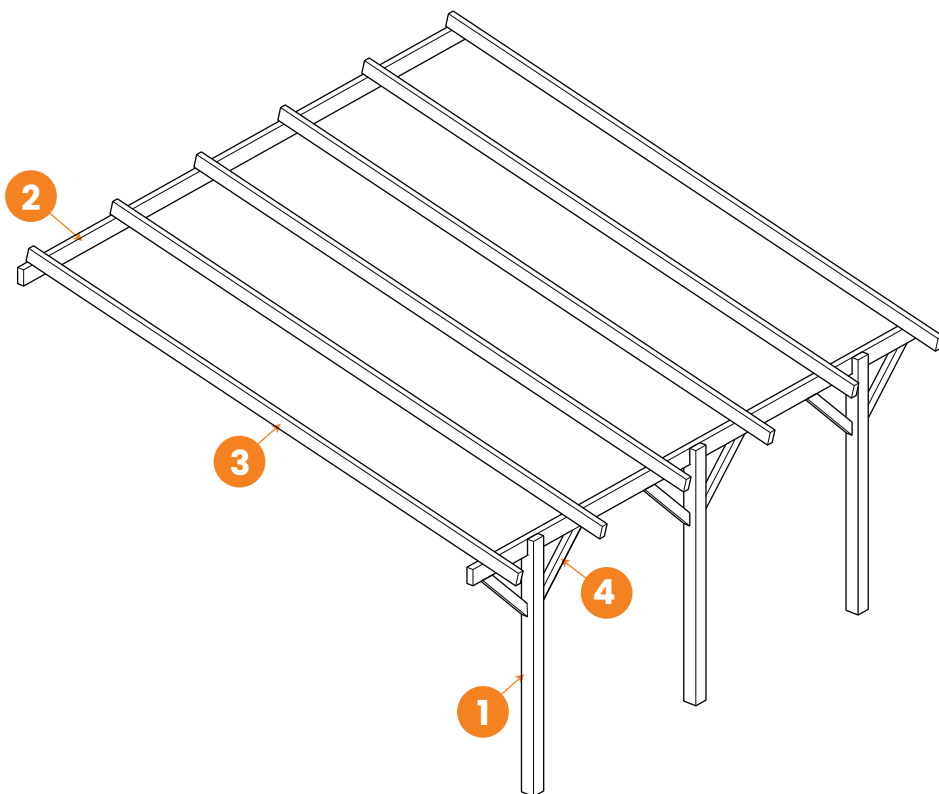

1

MONTAŻ BELKI NOŚNEJ I SŁUPÓW

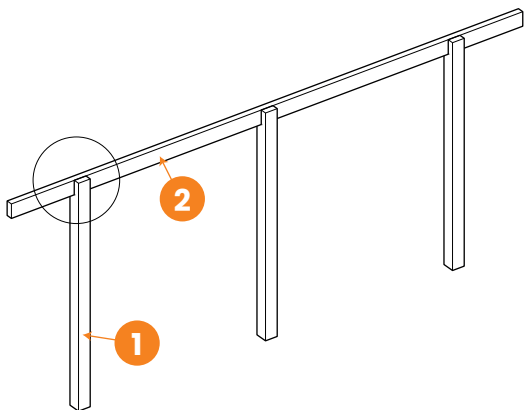
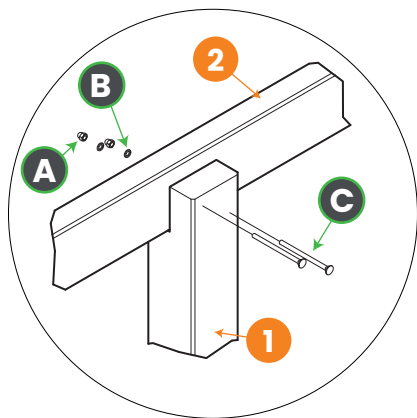
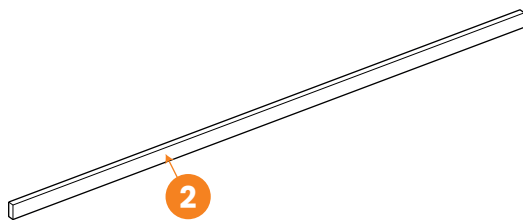
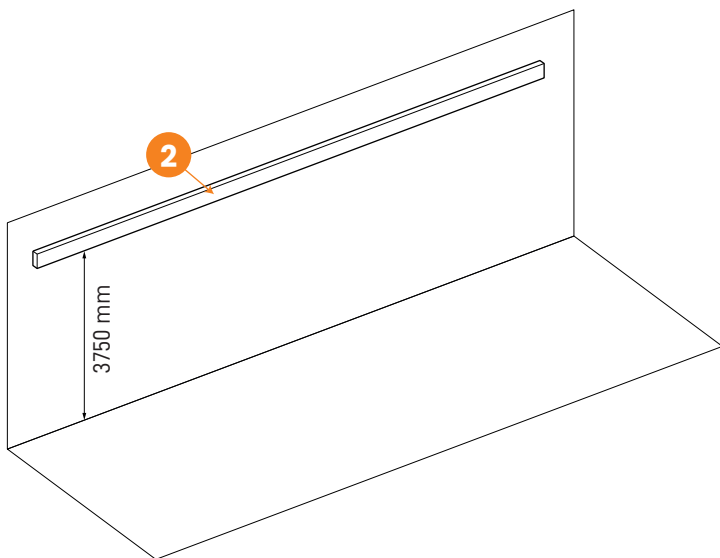

2

MONTAŻ ZAŚRZAŁÓW I KROKWI

