

ART 28149

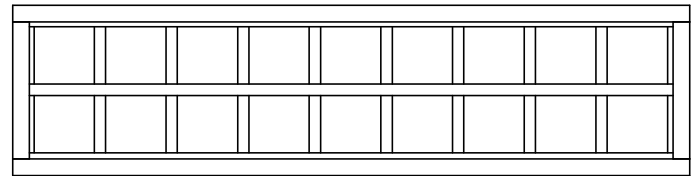

1 x 2

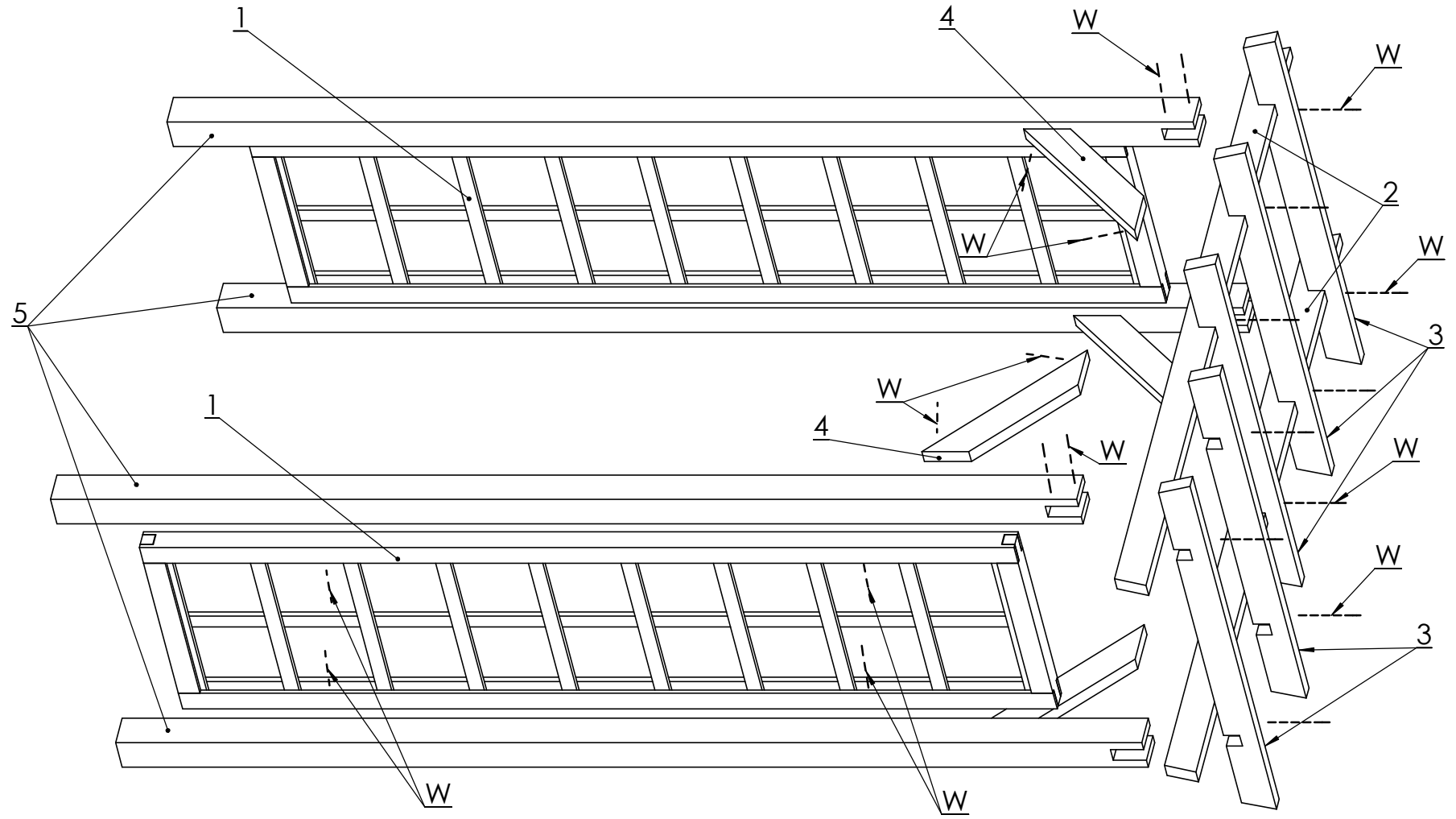
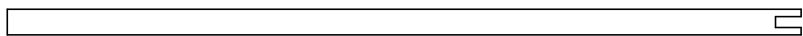

5 x 4

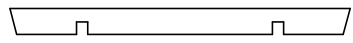

3 x 5

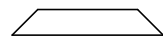

4 x 4

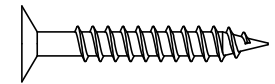

W 4x60 x 34

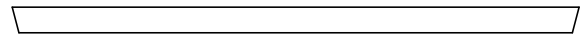

2 x 2